

Sectiune copetina cote peron /Canopy section for platform +0.38
scara/scale:1:50

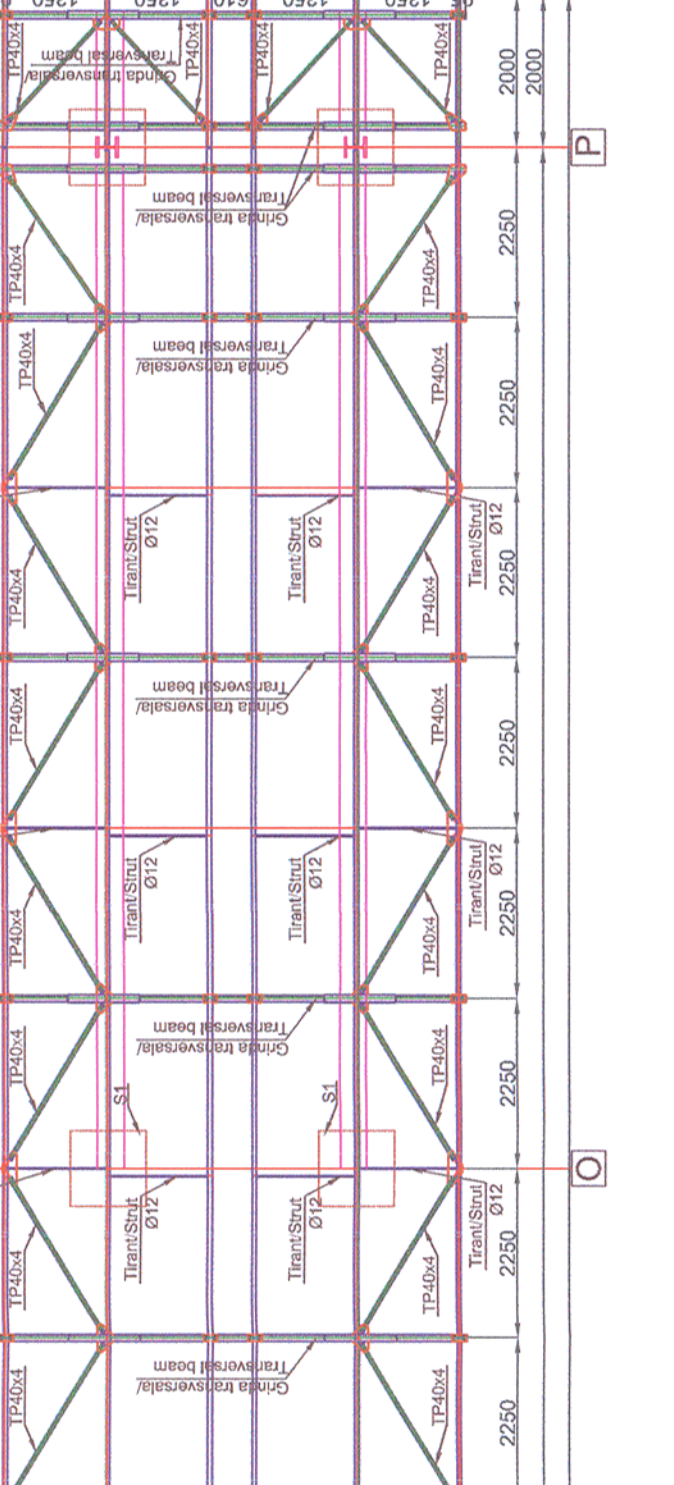

Sectiune copetina cote peron /Canopy section for platform +0.55
scara/scale:1:50

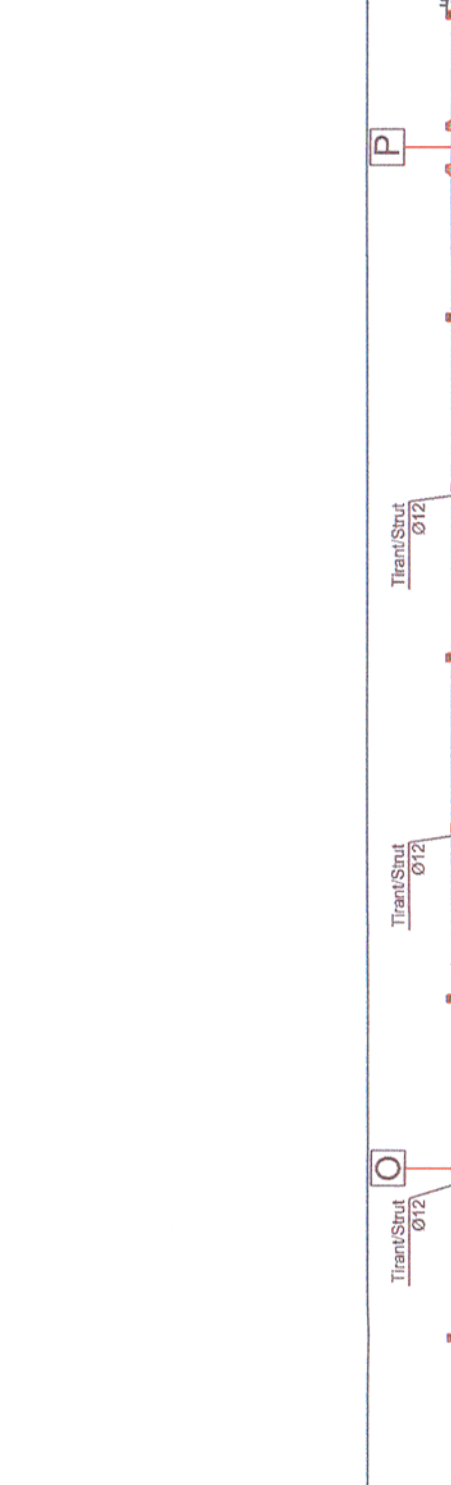

Sectiune copetina cote peron /Canopy section for platform +0.55
scara/scale:1:50

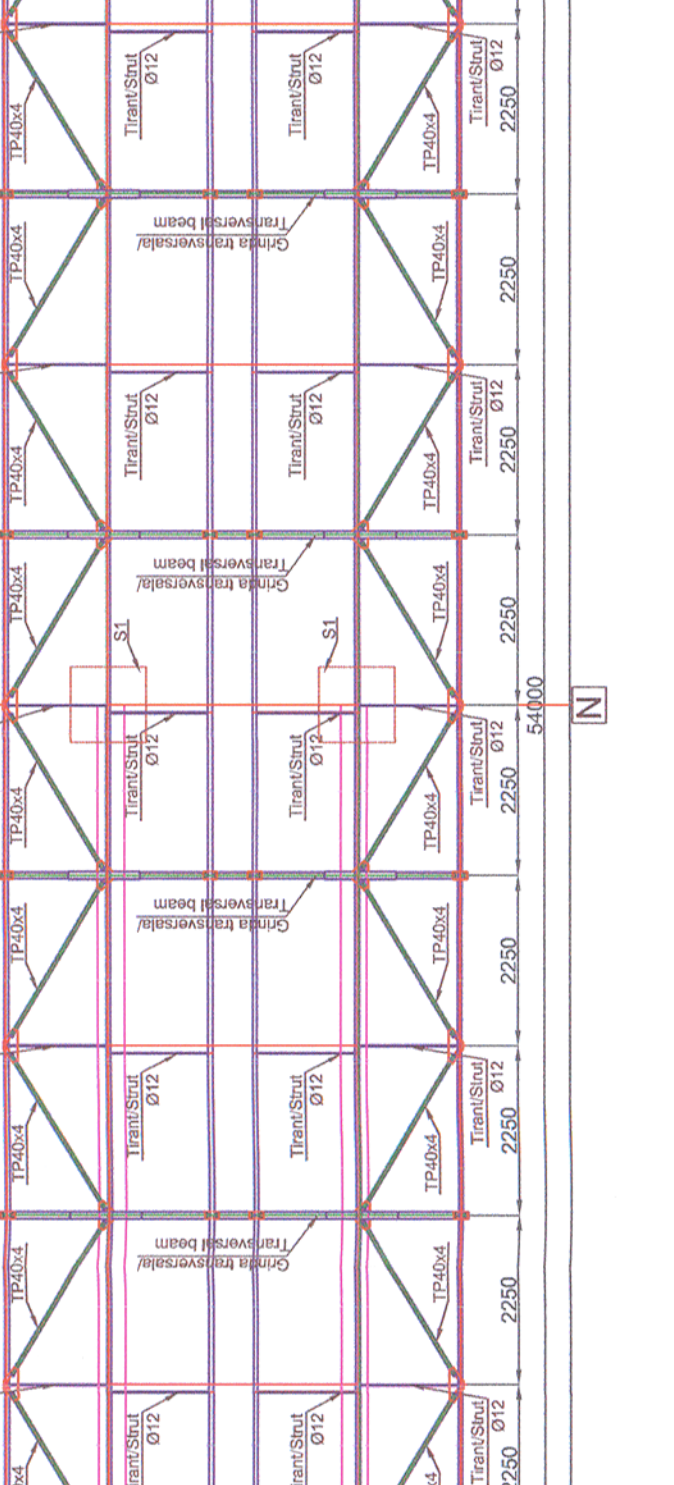
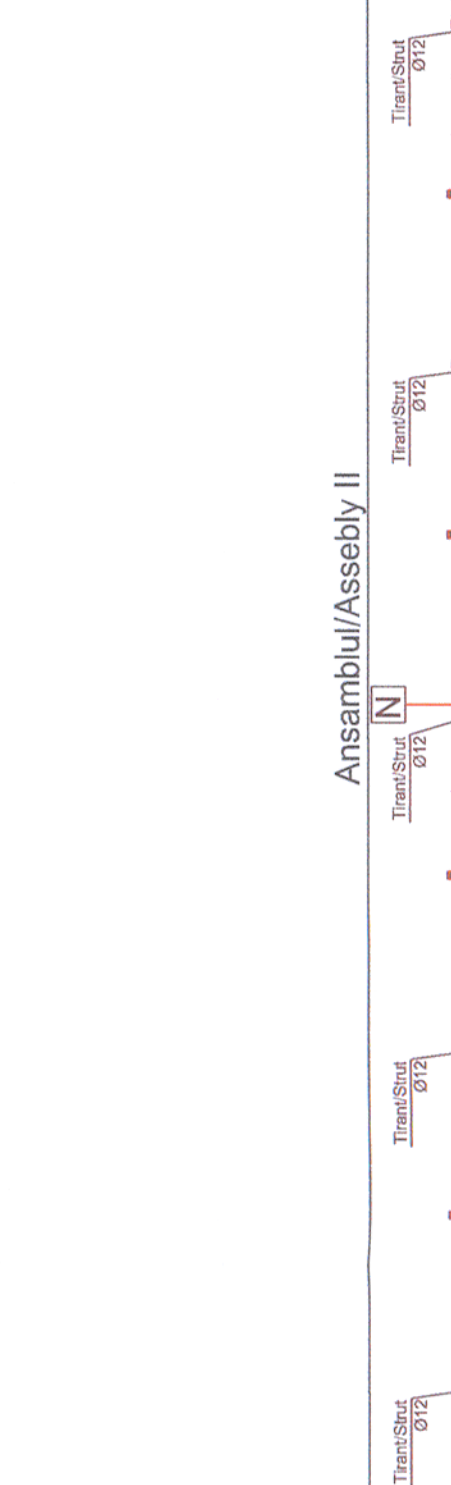

Sectiune copetina cote peron /Canopy section for platform +0.55
scara/scale:1:50

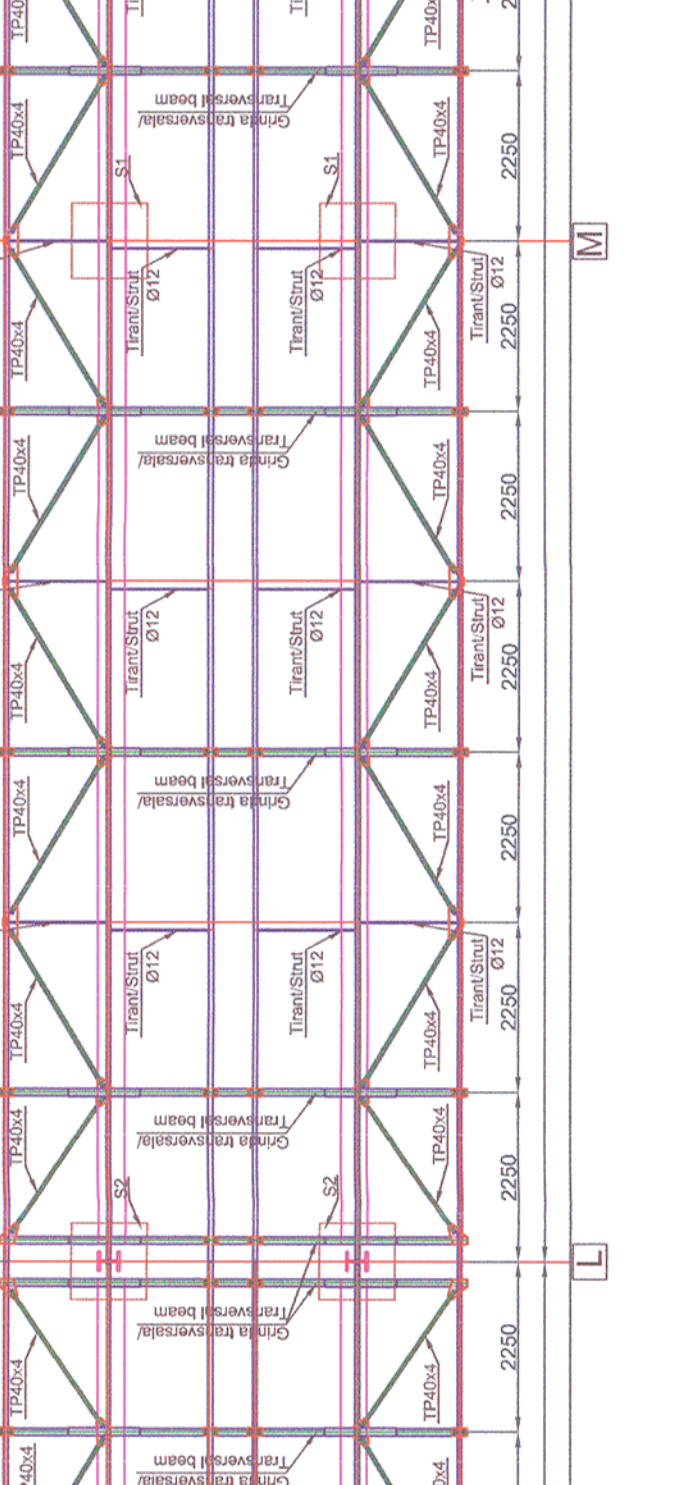

Sectiune copetina cote peron /Canopy section for platform +0.55
scara/scale:1:50

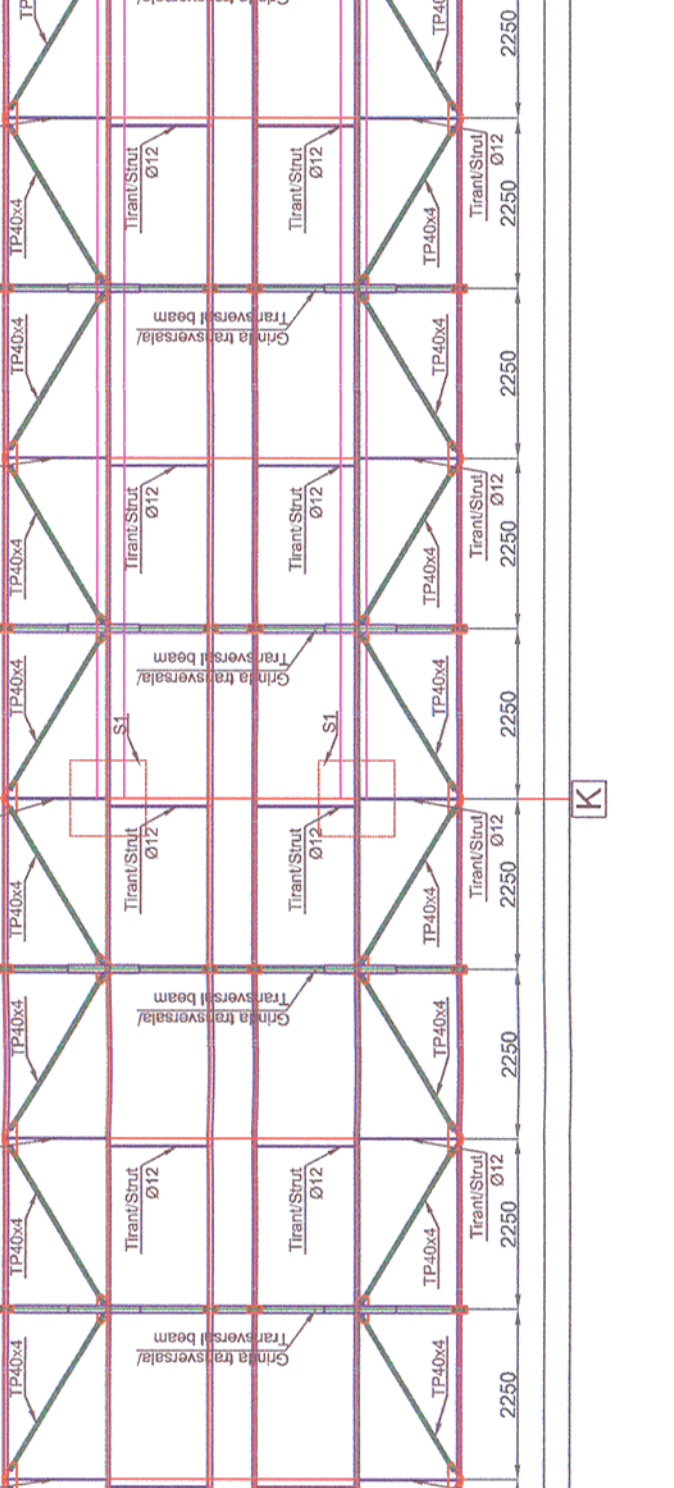

Sectiune copetina cote peron /Canopy section for platform +0.55
scara/scale:1:50

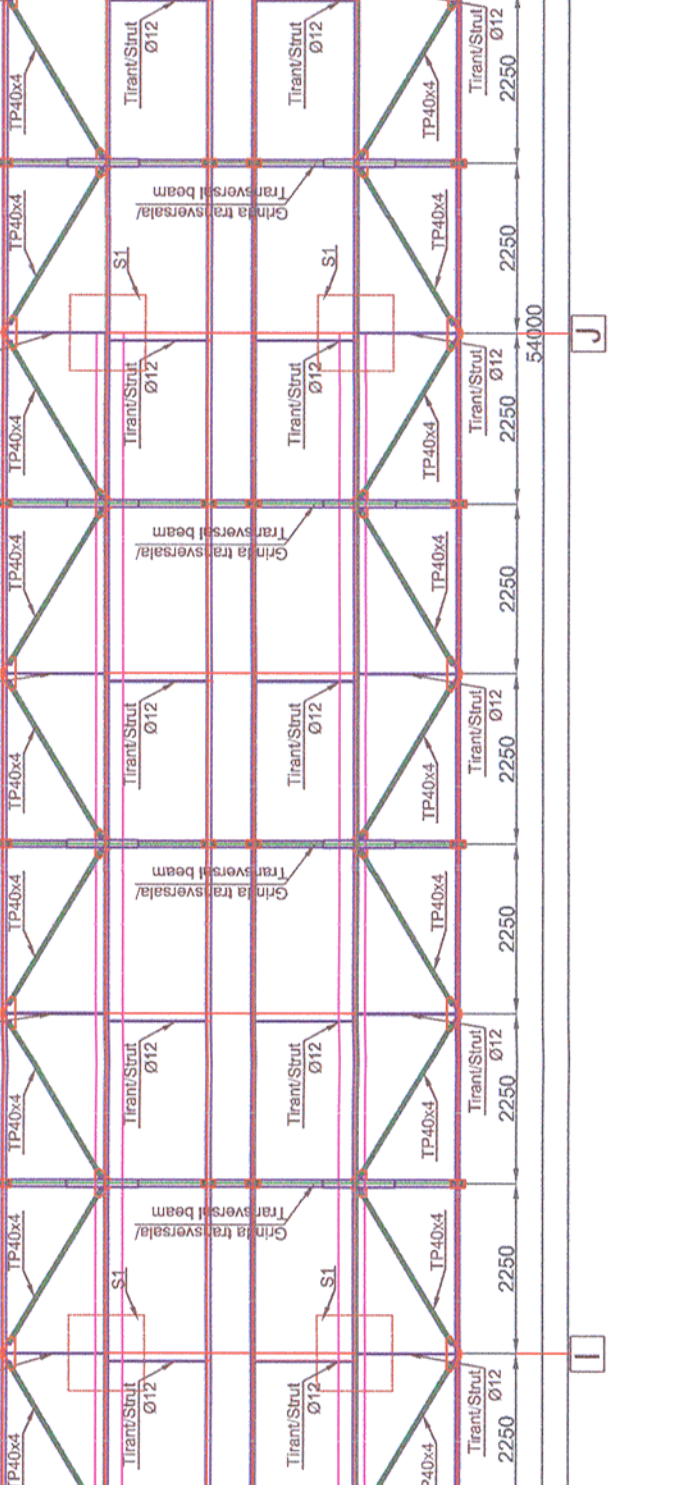
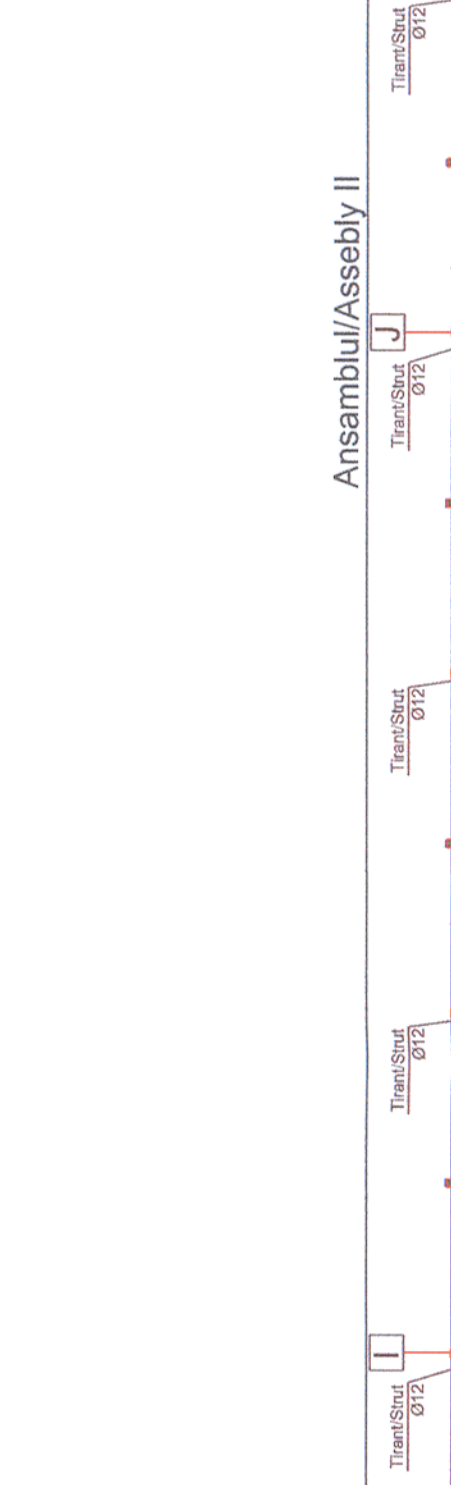

Sectiune copetina cote peron /Canopy section for platform +0.55
scara/scale:1:50

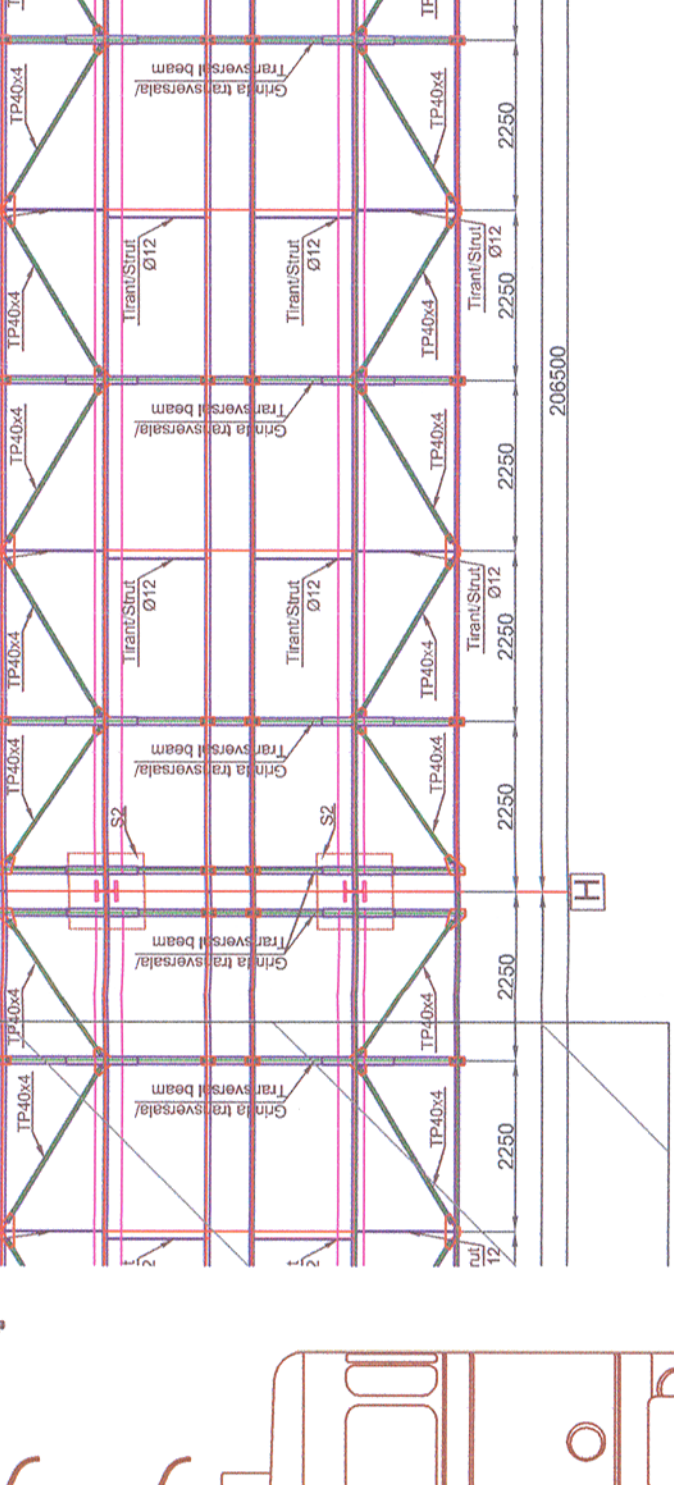
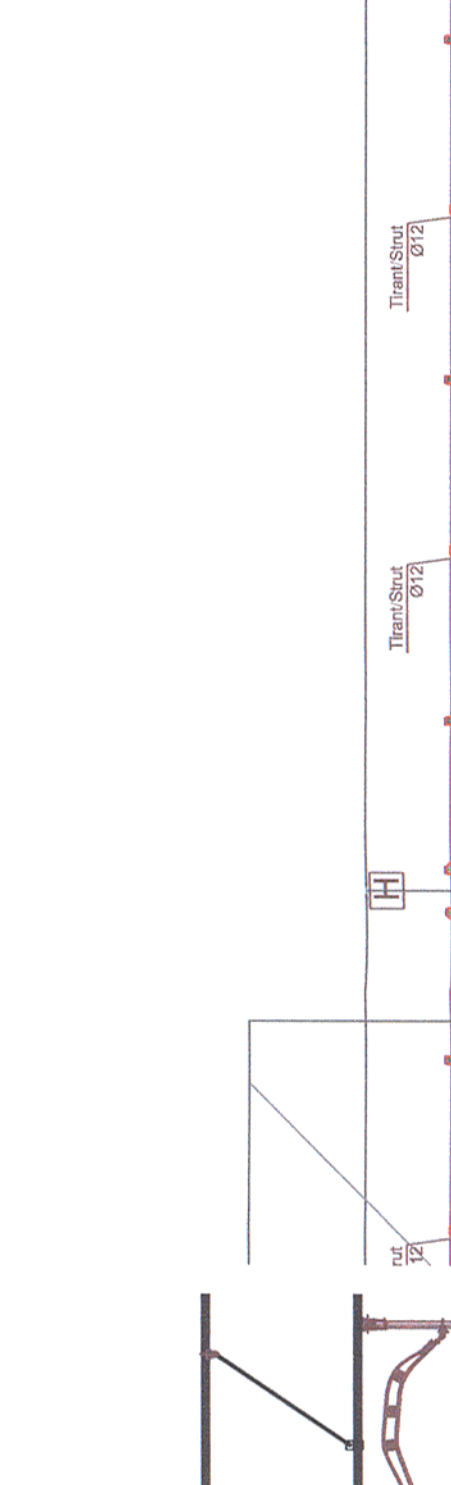

Sectiune copetina cote peron /Canopy section for platform +0.55
scara/scale:1:50

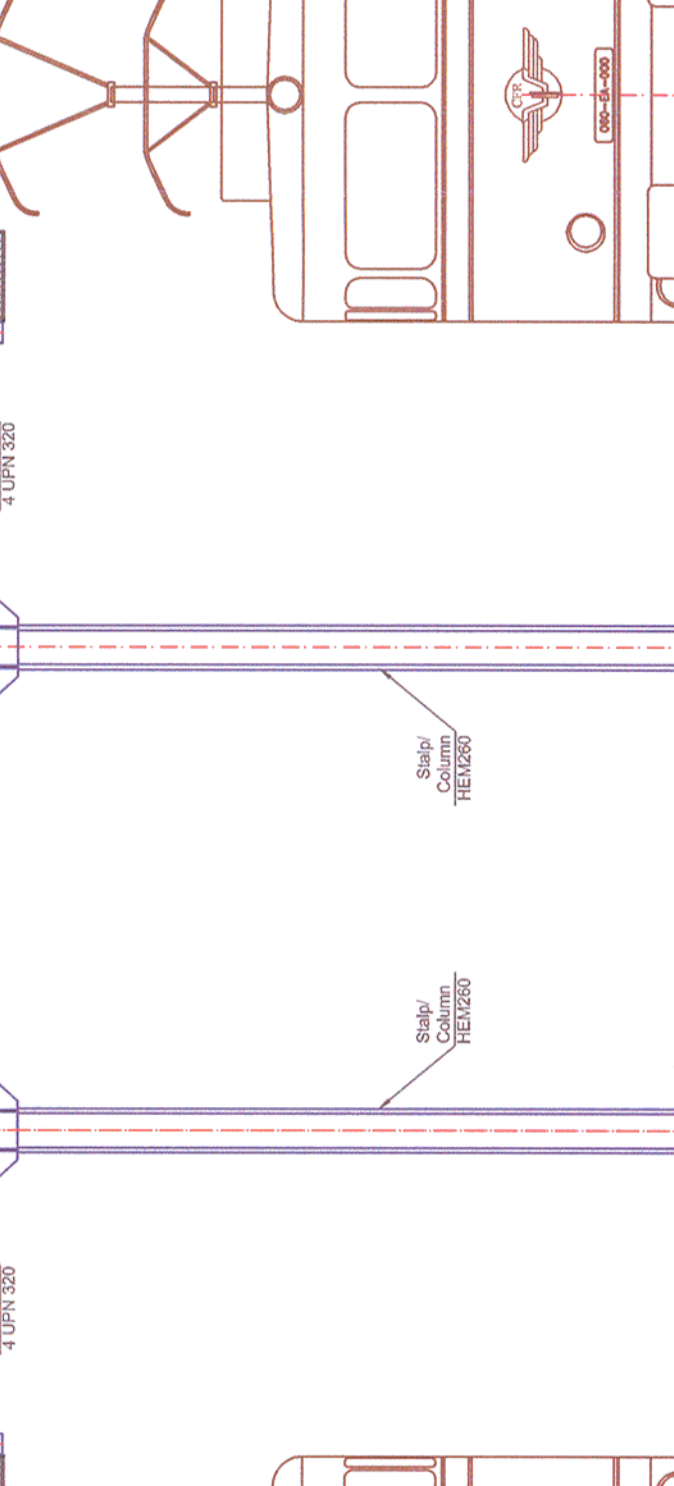
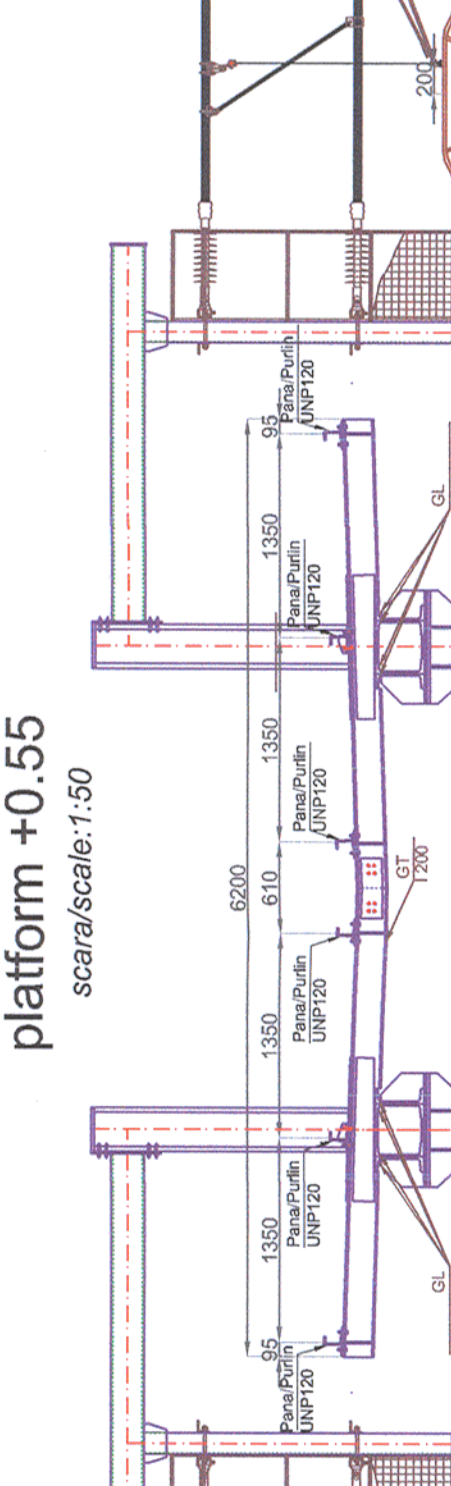

Sectiune copetina cote peron /Canopy section for platform +0.55
scara/scale:1:50

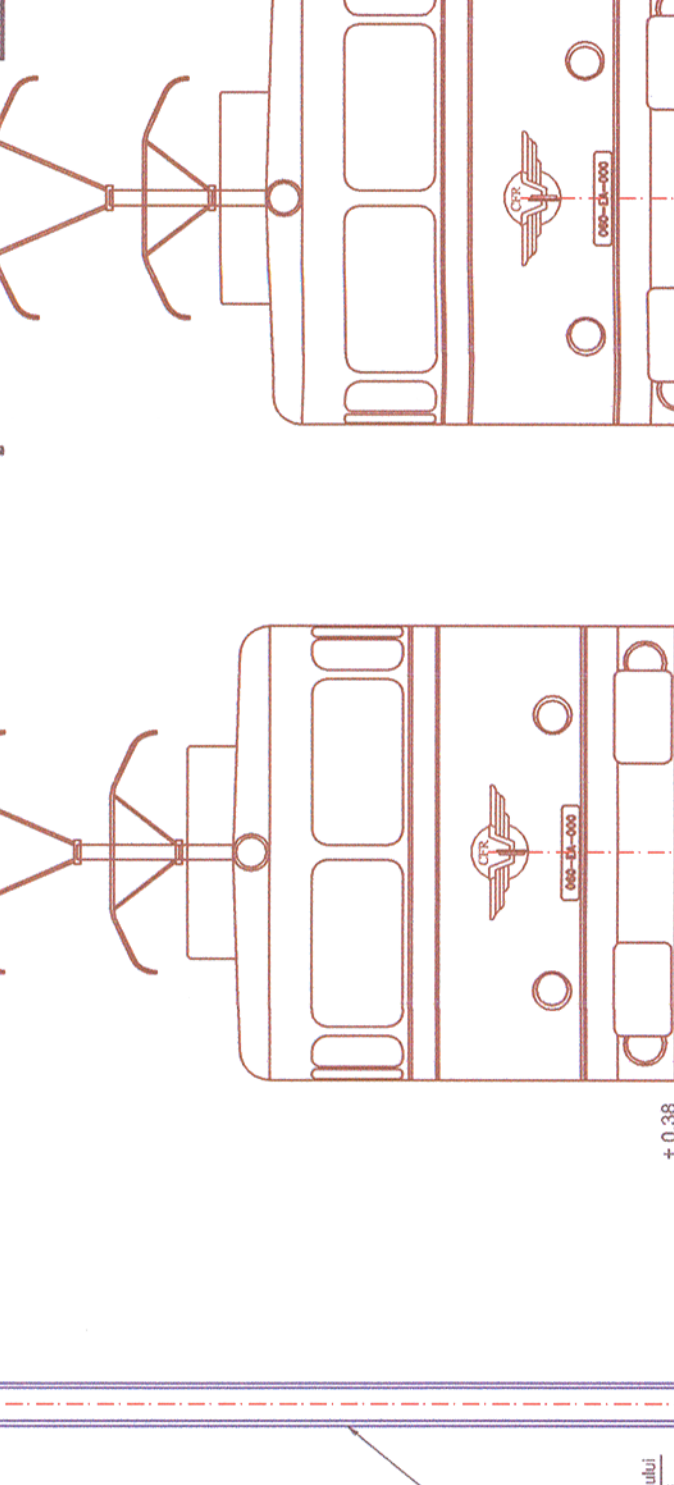
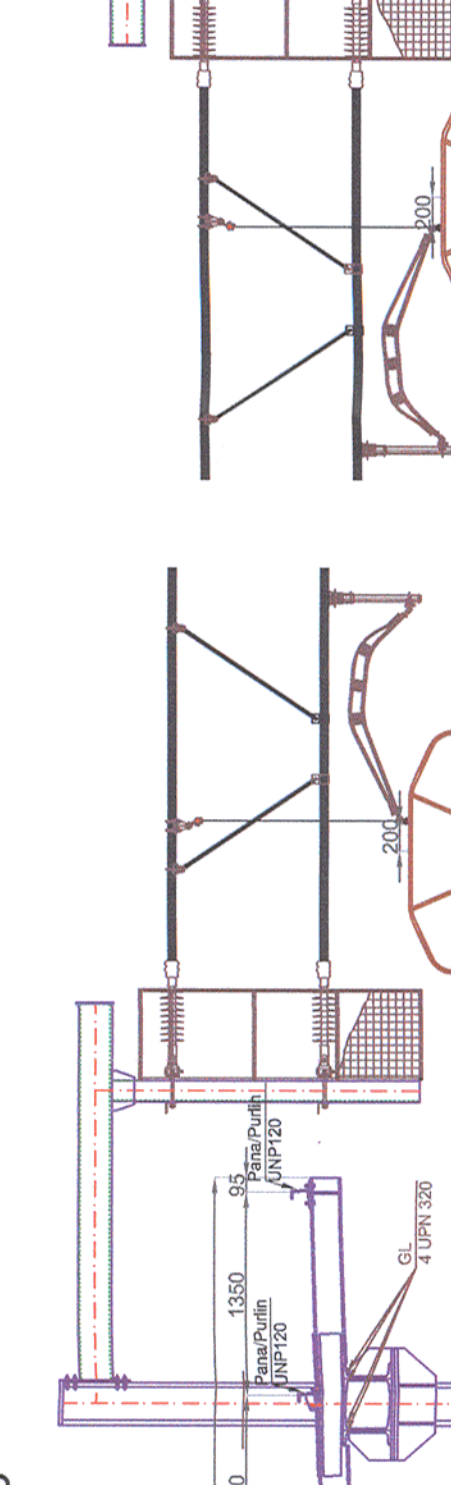

Sectiune copetina cote peron /Canopy section for platform +0.55
scara/scale:1:50

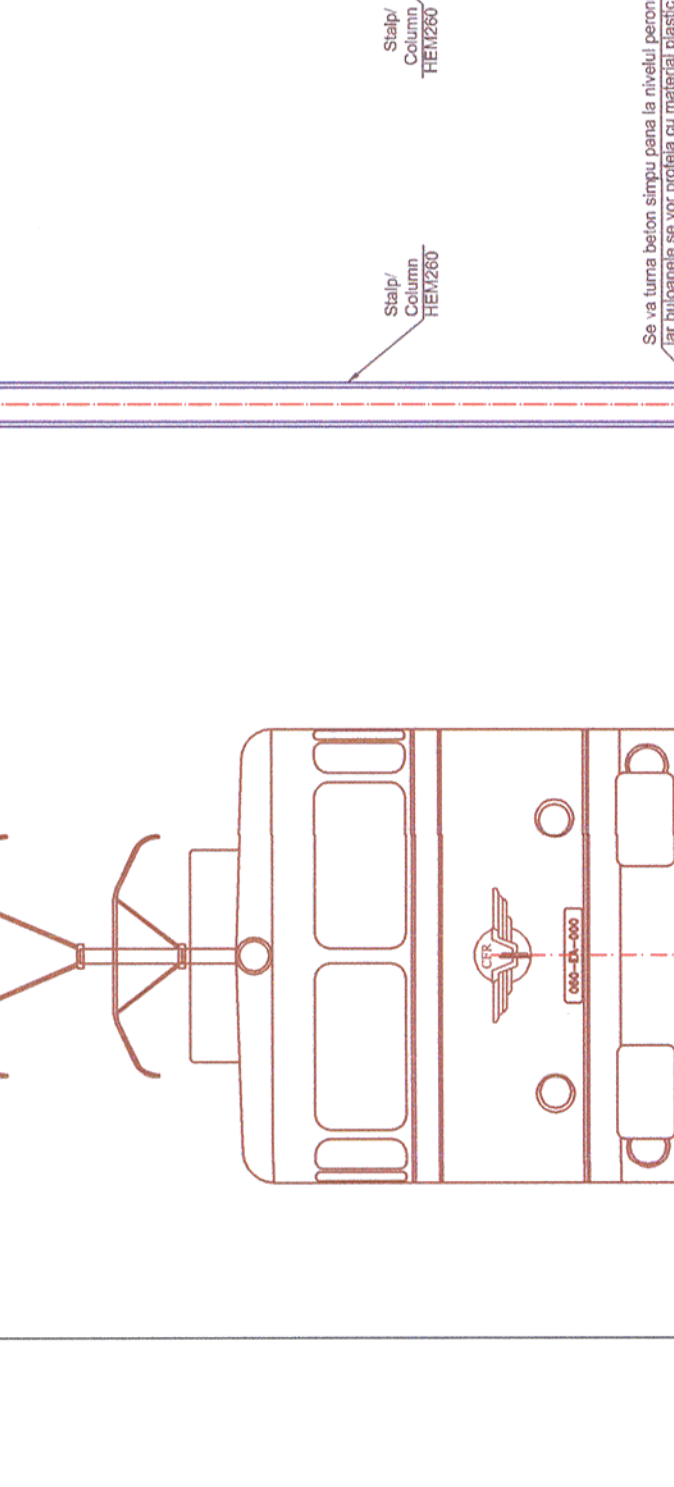
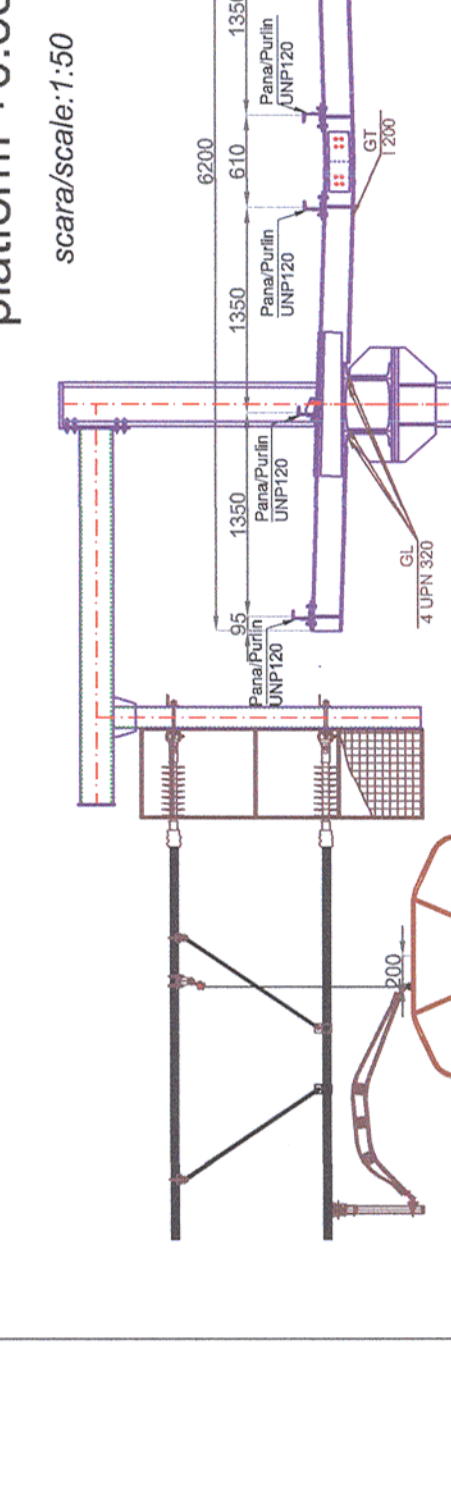

Sectiune copetina cote peron /Canopy section for platform +0.55
scara/scale:1:50

Sectiune copetina cote peron /Canopy section for platform +0.55
scara/scale:1:50

Sectiune copetina cote peron /Canopy section for platform +0.55
scara/scale:1:50

Sectiune copetina cote peron /Canopy section for platform +0.55
scara/scale:1:50

Sectiune copetina cote peron /Canopy section for platform +0.55
scara/scale:1:50

Sectiune copetina cote peron /Canopy section for platform +0.55
scara/scale:1:50

Sectiune copetina cote peron /Canopy section for platform +0.55
scara/scale:1:50

Sectiune copetina cote peron /Canopy section for platform +0.55
scara/scale:1:50

Sectiune copetina cote peron /Canopy section for platform +0.55
scara/scale:1:50

Sectiune copetina cote peron /Canopy section for platform +0.55
scara/scale:1:50

Sectiune copetina cote peron /Canopy section for platform +0.55
scara/scale:1:50

Sectiune copetina cote peron /Canopy section for platform +0.55
scara/scale:1:50

Sectiune copetina cote peron /Canopy section for platform +0.55
scara/scale:1:50

Sectiune copetina cote peron /Canopy section for platform +0.55
scara/scale:1:50

Sectiune copetina cote peron /Canopy section for platform +0.55
scara/scale:1:50

Sectiune copetina cote peron /Canopy section for platform +0.55
scara/scale:1:50

Sectiune copetina cote peron /Canopy section for platform +0.55
scara/scale:1:50

Sectiune copetina cote peron /Canopy section for platform +0.55
scara/scale:1:50

Sectiune copetina cote peron /Canopy section for platform +0.55
scara/scale:1:50

Sectiune copetina cote peron /Canopy section for platform +0.55
scara/scale:1:50

Sectiune copetina cote peron /Canopy section for platform +0.55
scara/scale:1:50

Sectiune copetina cote peron /Canopy section for platform +0.55
scara/scale:1:50

Sectiune copetina cote peron /Canopy section for platform +0.55
scara/scale:1:50

